

SECTION A-A

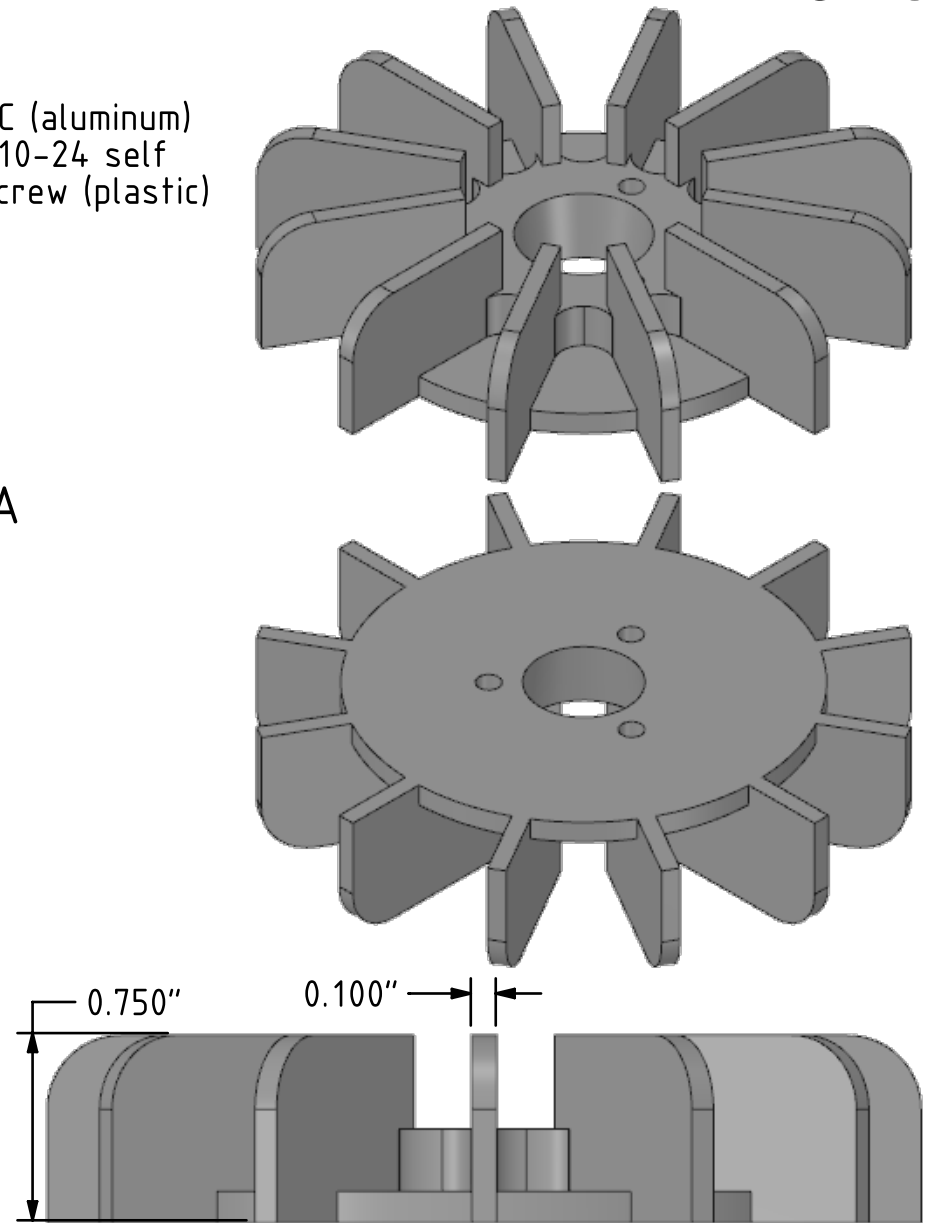

Material	Part Number
Plastic	8900-2
Aluminum	8900-1